



SHELF SET

#P230 - Wildlife 2 Set

These Wildlife shelf projects will enhance your home. Use them to hold all sorts of treasures.
8 -12 designs per set!

#P230 - Wildlife 2 Shelves			
Description	Item	Qty	Size
Top	A	1	3/8" T x 2 1/2" W x 8" L
Bottom	B	1	3/8" T x 1 1/4" W x 8" L
Side	C	2	3/8" T x 3 1/2" W x 6 3/4" L
Shelf	D	2	3/8" T x 3 1/2" W x 7 7/8" L
Center Divider	E	1	3/8" T x 3 3/4" W x 4" L
Door	F	2	3/8" T x 3 3/4" W x 4" L
Door	G	2	3/8" T x 3 3/4" W x 4" L
Arch	H	1	3/8" T x 3" W x 6" L
Side	I	2	3/8" T x 4" W x 9" L
Top & Bottom	J	1 ea	1/4" T x 4 5/8" W x 6 1/2" L
Shelf	K	1	3/8" T x 4" W x 5 1/4" L
Shelf Top	L	1	1/4" T x 3 3/4" W x 10 1/8" L
Shelf Back	M	1	1/4" T x 3 3/4" W x 8" L
Shelf Back	N	1	1/4" T x 3 3/4" W x 8" L
Bracket	O	2	1/4" T x 3" W x 4 1/4" L
Bracket	P	2	1/4" T x 3 1/2" W x 5 1/4" L
Shelf Side	Q	2	1/4" T x 4" W x 9 1/8" L
Shelf Side	R	2	1/4" T x 4" W x 9" L
Shelf Side	S	2	1/4" T x 4" W x 9" L
Shelf	T	2	1/4" T x 3 7/8" W x 8 1/4" L
Pillar	U	2	3/8" T x 5/8" W x 6" L
Gallery Rail	V	1	1/4" T x 5/8" W x 9 3/4" L
Overlays	W	2 of choice	1/8" - 1/16" T x " W x 4" L

GREAT AMERICAN SCROLLSAW



DOWNLOADABLE PATTERNS™

The Berry Basket © Copyright 2002 • All Rights Reserved
www.greatamericanscrollsaw.com • a division of The Berry Basket

#P230 Wildlife 2 Shelf Set Instructions

1. Select your material from a variety of hardwoods or solid core plywood.
2. Measure each pattern piece and cut the work pieces to size accordingly. Sand as necessary.
3. Make all pattern pieces by adhering the paper patterns to the work pieces with a repositionable spray adhesive. Cut the outer shapes and any interior designs. And drill where indicated.
4. Remove all paper patterns. Sand where needed. The edges can be rounded by sanding or using a small roundover router bit if desired.
5. Assemble the Shelf by attaching the pieces with glue and finishing nails. Add hinges and shaker pegs where indicated. Finish as desired.

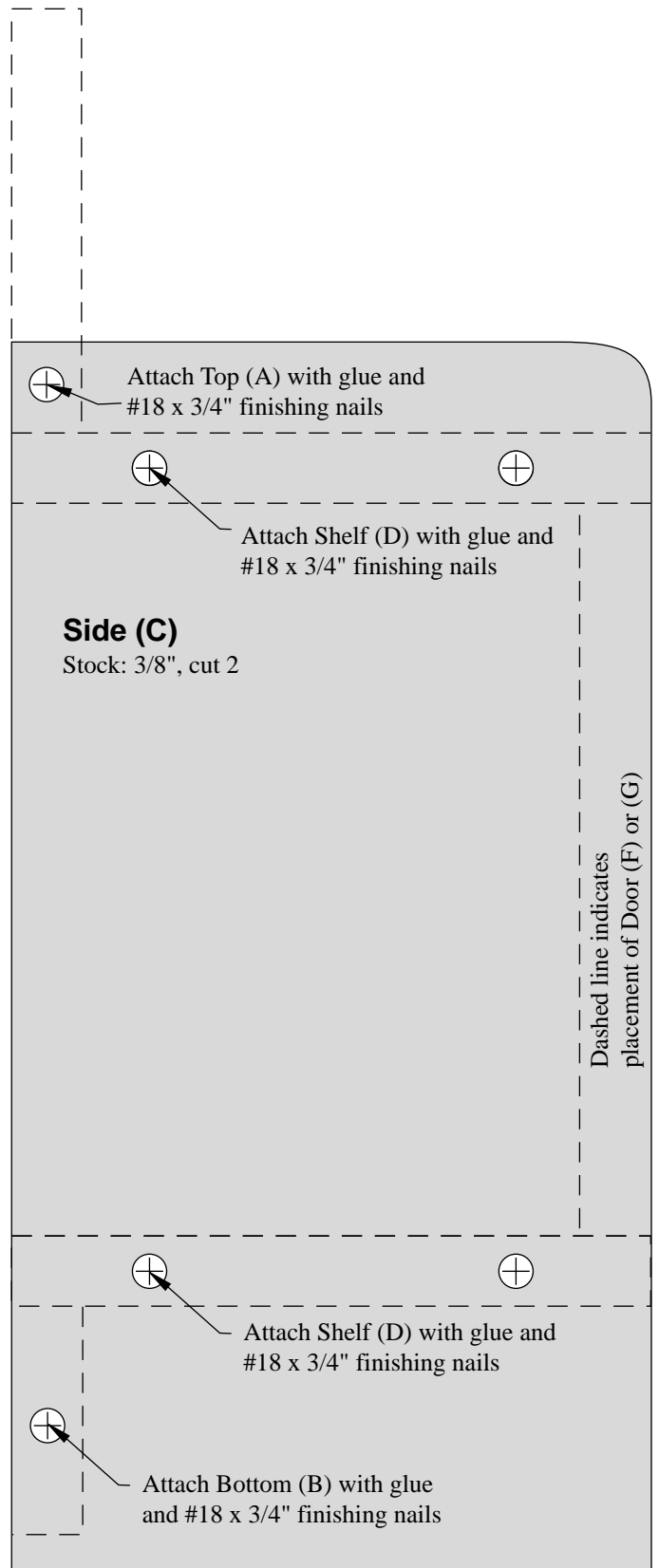
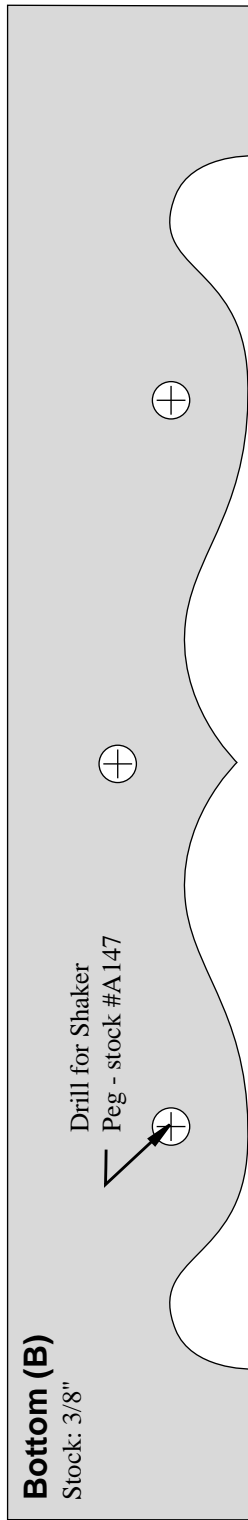
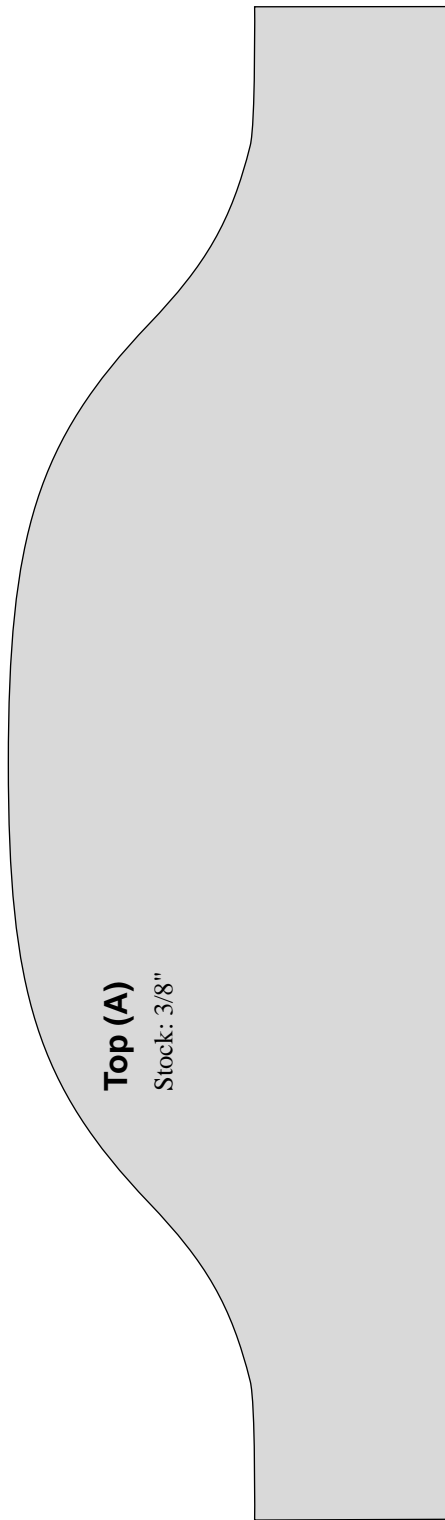

Shelf (D)

Stock: 3/8", cut 2

Attach Center Divider (E) with
glue and #18 x 3/4" finishing nails

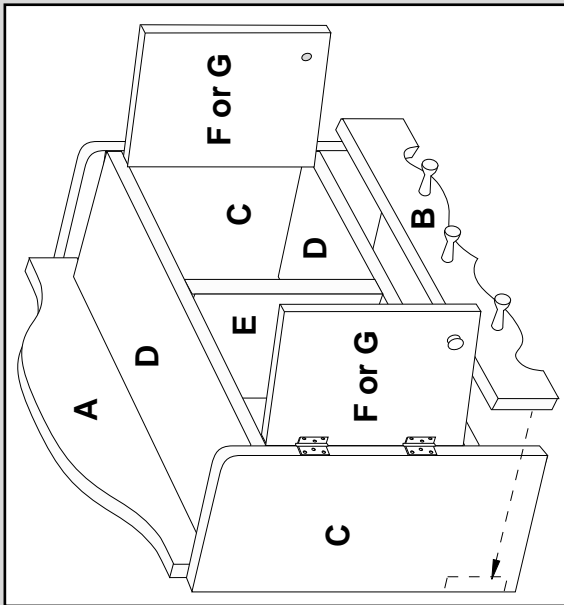

Center Divider (E)

Stock: 3/8"

Door (F) Stock: 3/8", cut 2

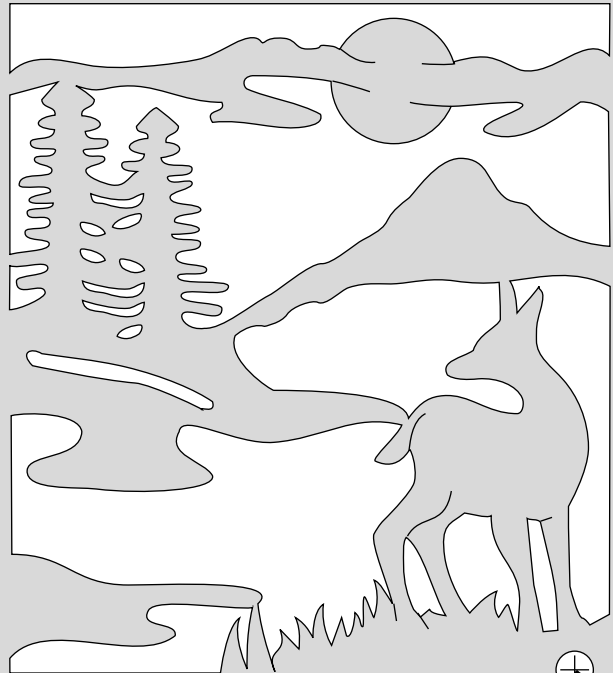

Drill for Shaker
Peg - stock #A147



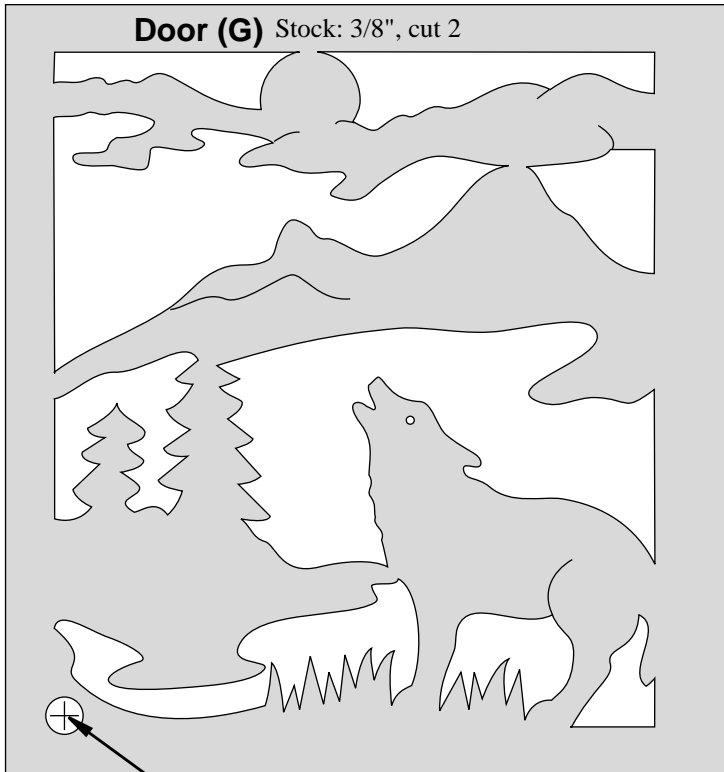

Drill for Shaker
Peg - stock #A147

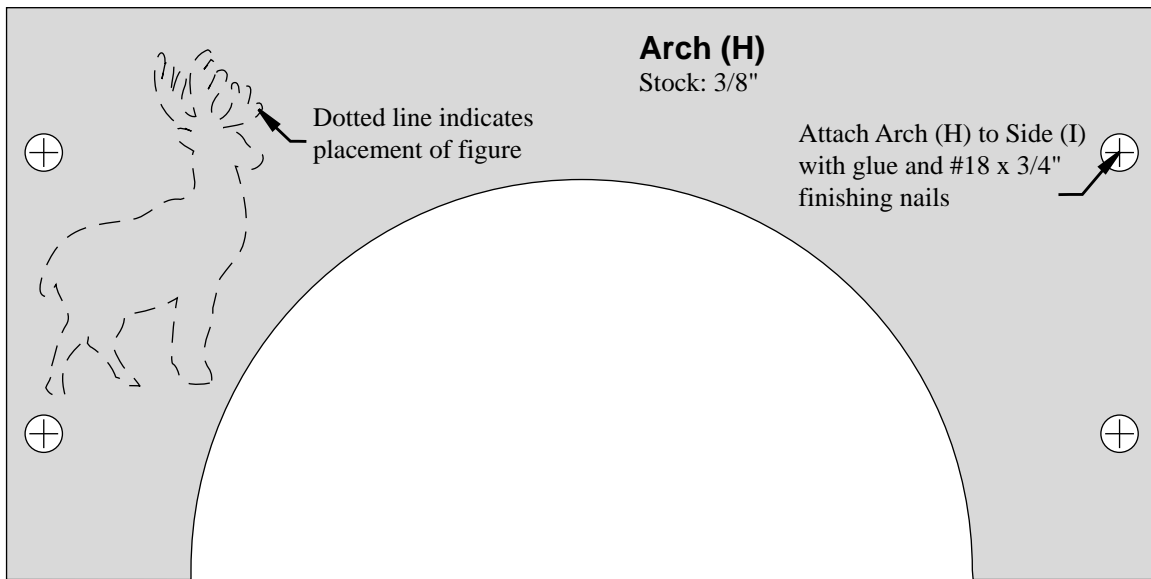
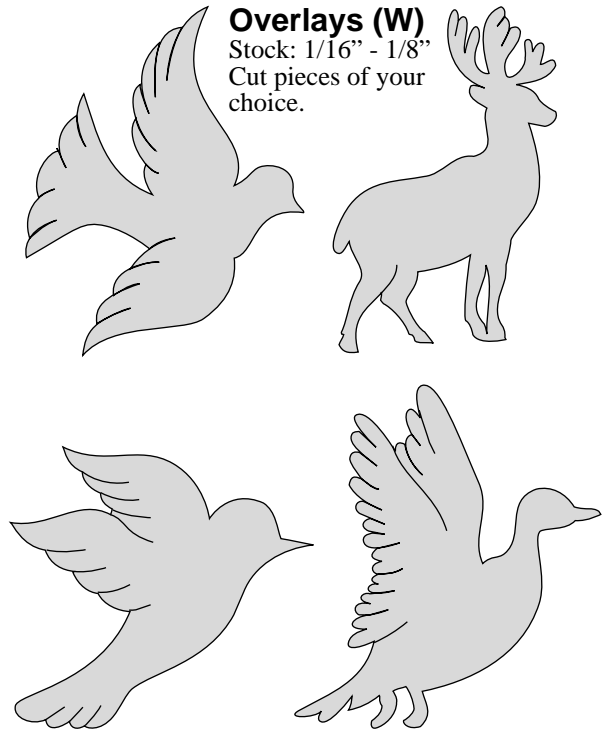

Shelf (K)

Stock: 3/8"

Side view of Top (J)

Side (I)

Stock: 3/8", cut 2

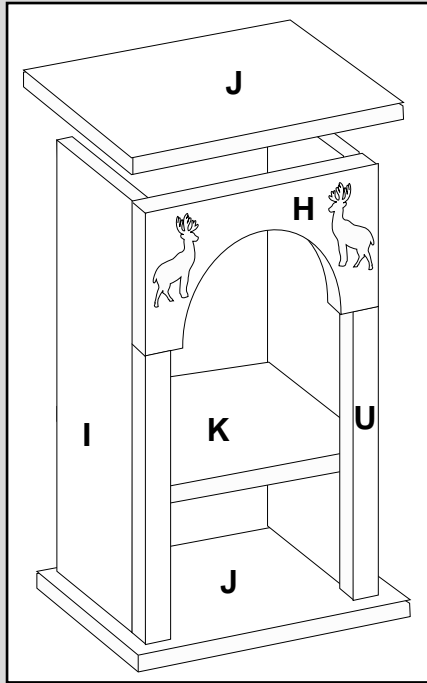

Side view of Arch (H)

Side view of Pillar (U)



Side view of Shelf (K)



Attach Shelf (K) with glue and #18 x 3/4" finishing nails

Side view of Bottom (J)

Top & Bottom (J)

Stock: 1/4", cut 1 of each

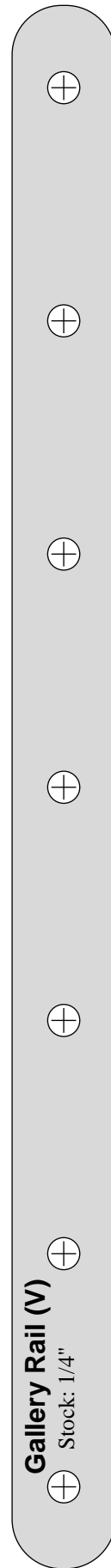
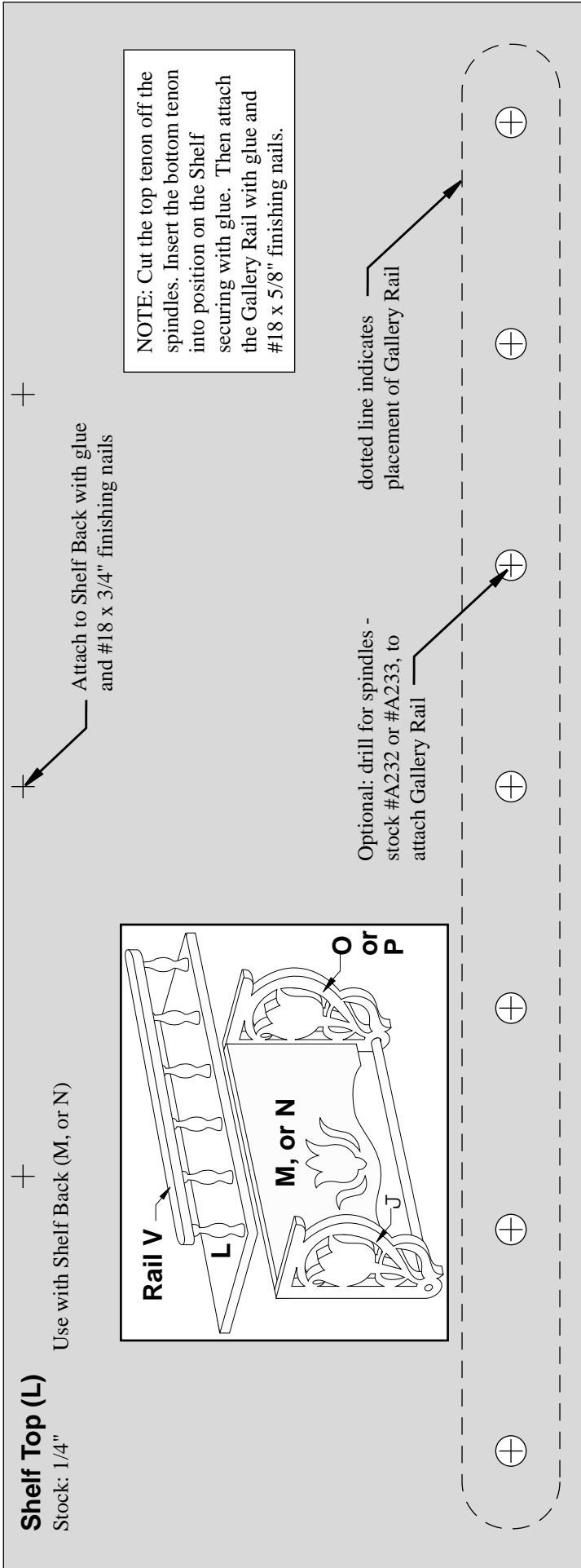

Shelf Back (M)

Stock: 1/4"
Use with Shelf Top (L) and
Bracket (O or P)

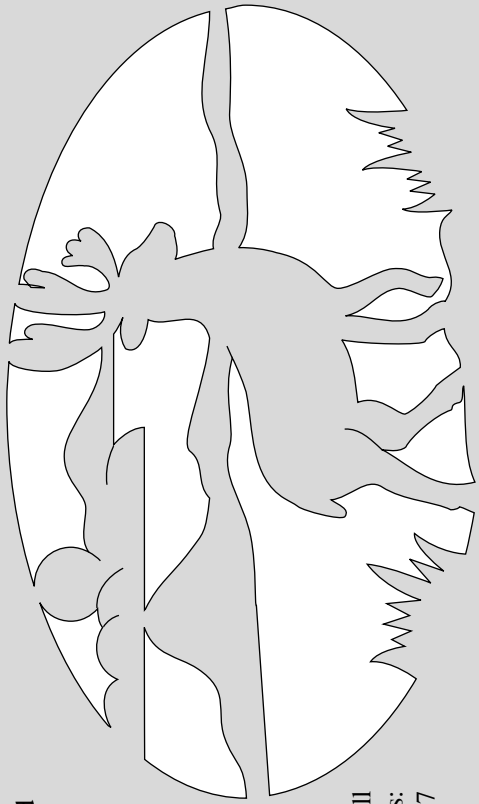

Optional: drill
for Shaker pegs:
stock #A147

Shelf Back (N)

Stock: 1/4"
Use with Shelf Top (L) and
Bracket (O or P)

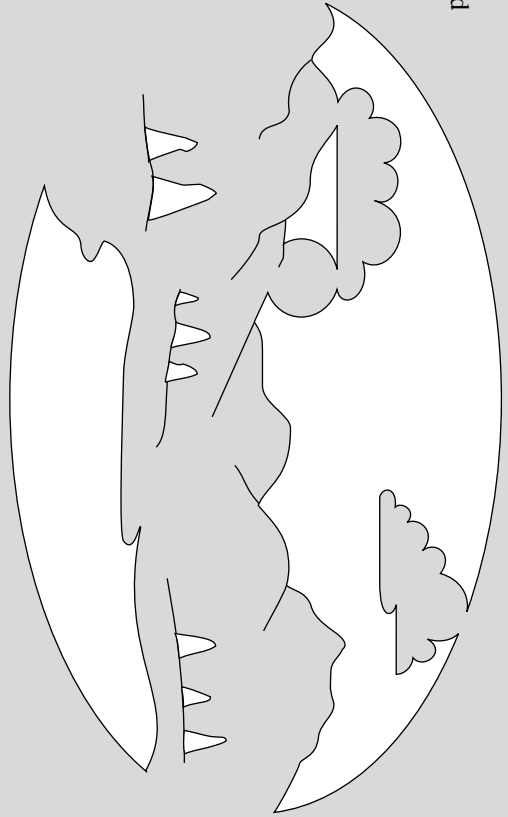

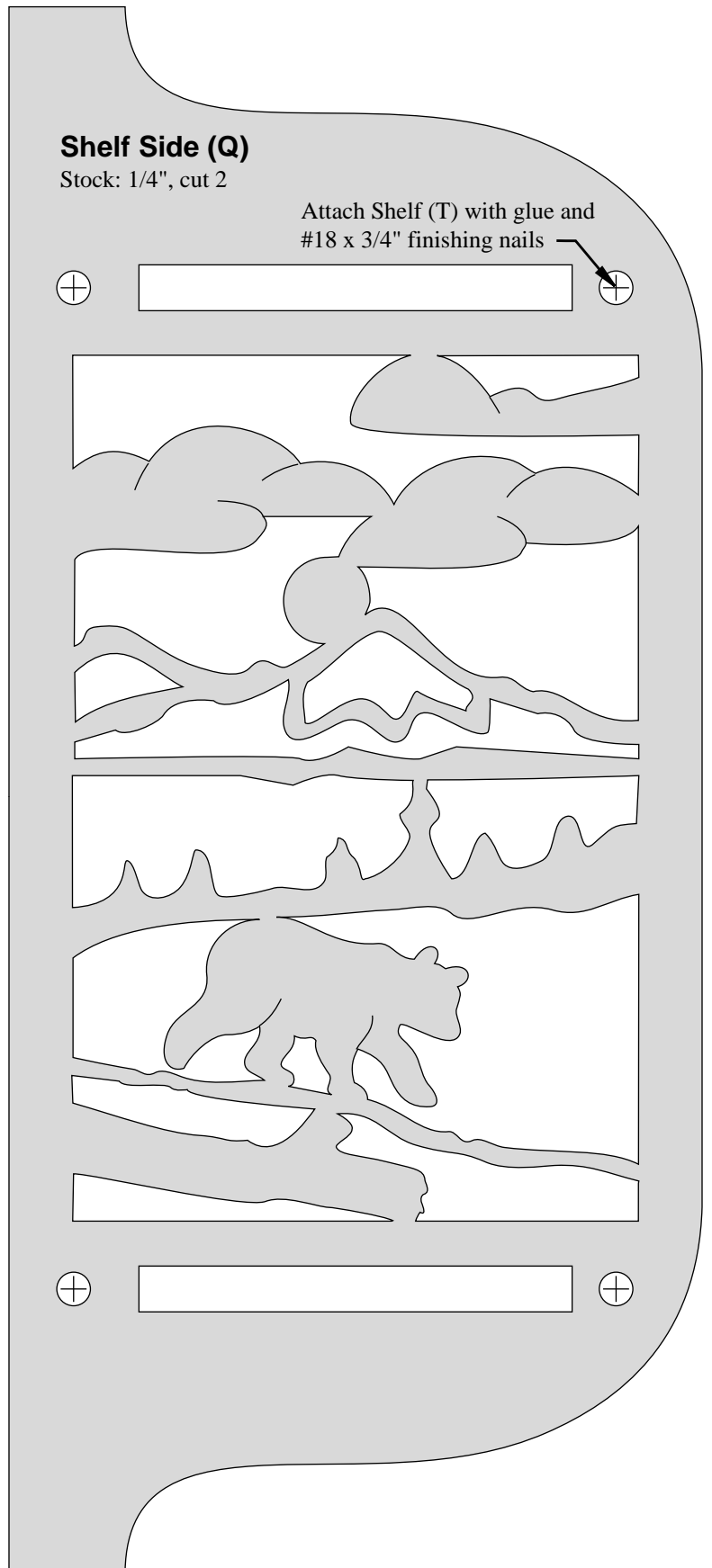
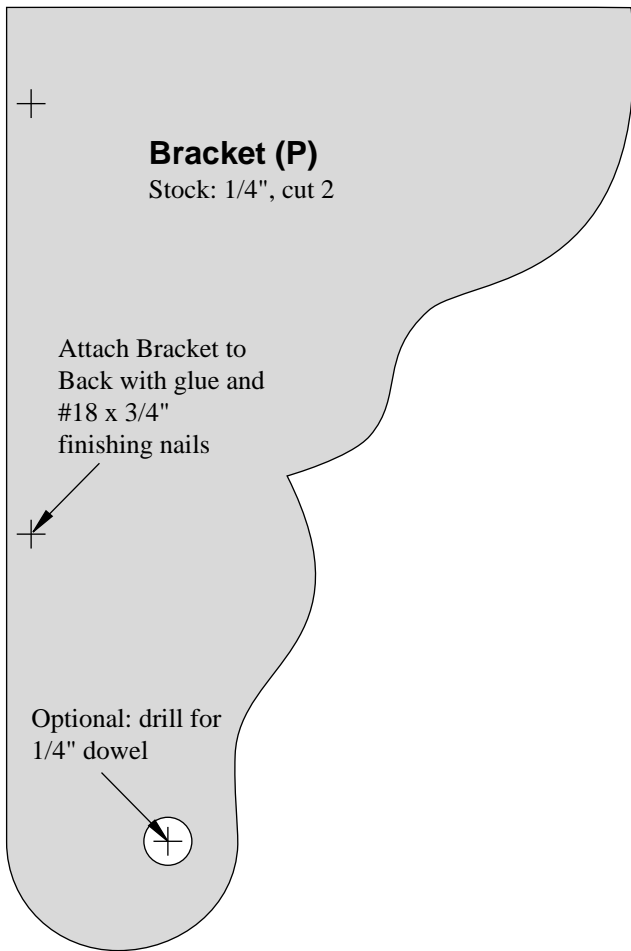
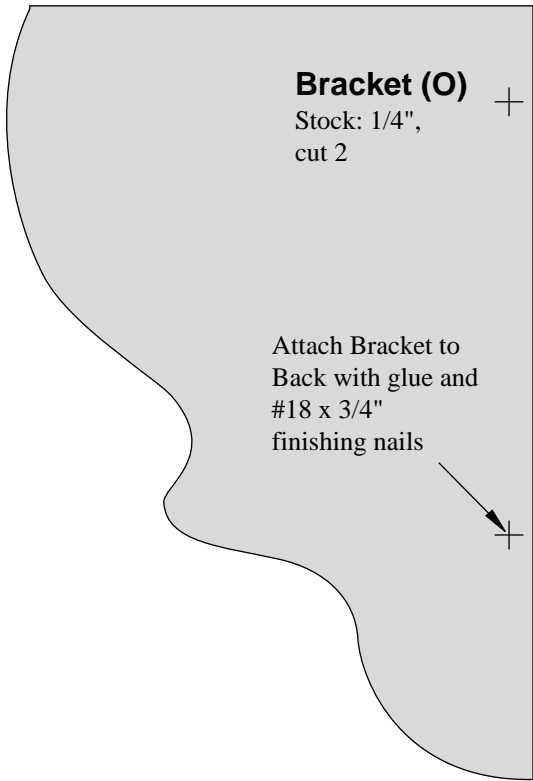

Shelf Side (R)

Stock: 1/4", cut 2

Attach Shelf (T) with glue and #18 x 3/4" finishing nails

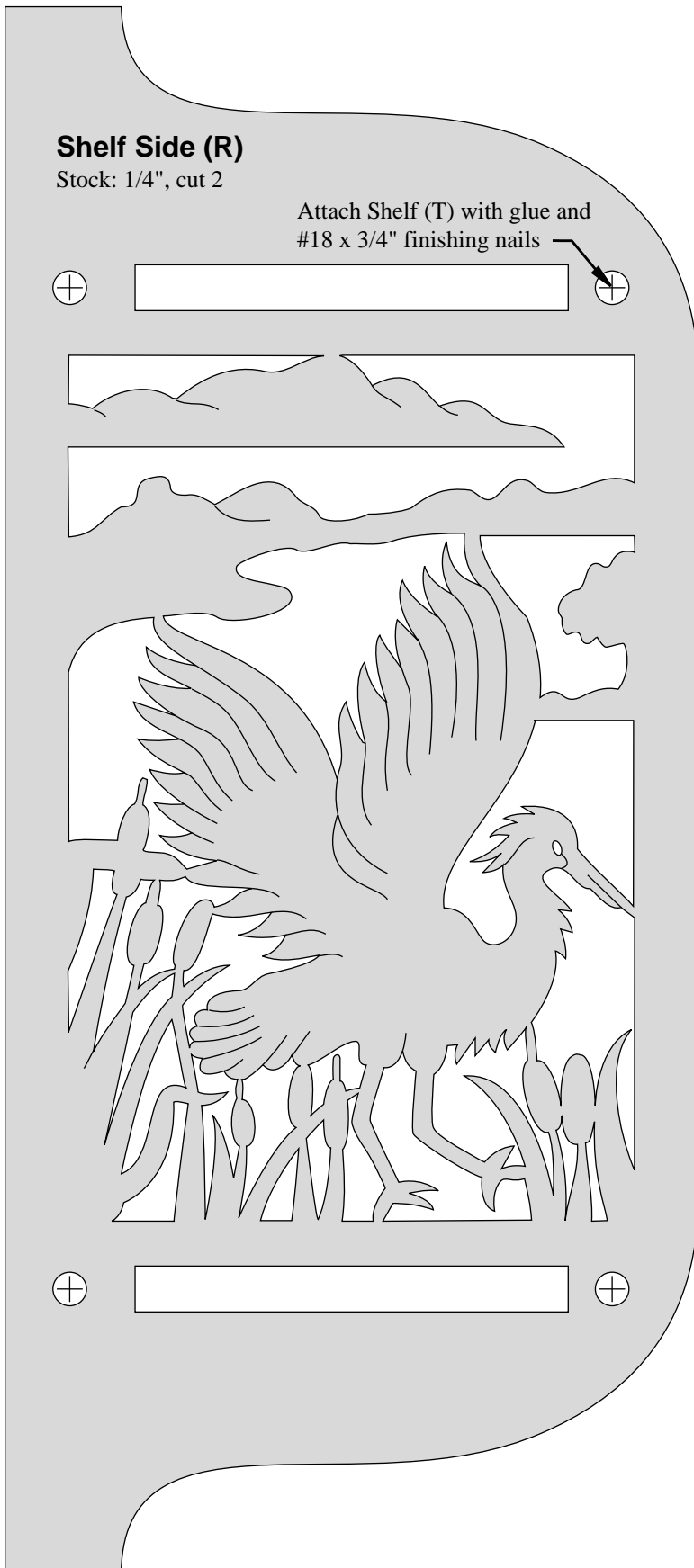

Shelf Side (S)

Stock: 1/4", cut 2

Attach Shelf (T) with glue and #18 x 3/4" finishing nails

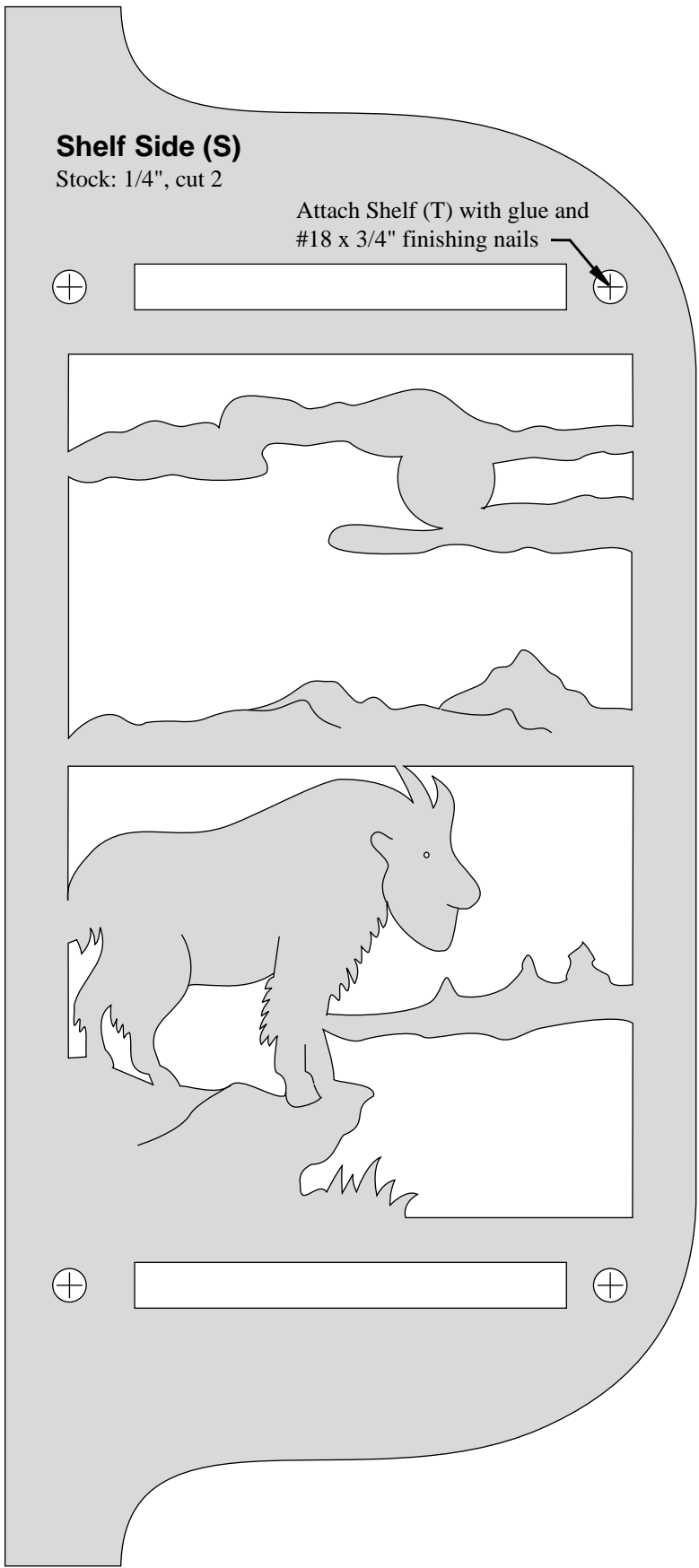

Shelf (T)

Stock: 1/4", cut 2

Use with Shelf Side (Q, R, S)

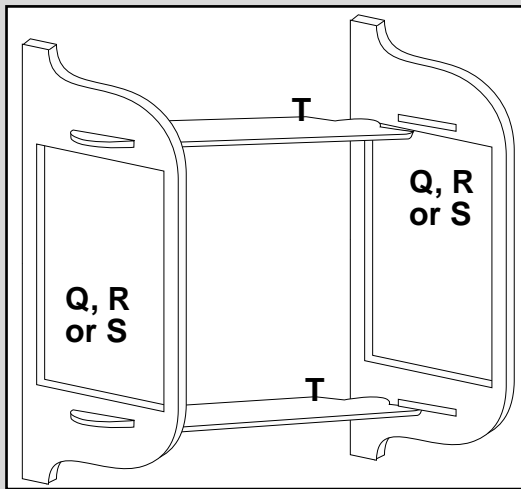

Attach Pillar to Side with glue and
#18 x 3/4" finishing nails



Pillar (U)

Stock: 3/8", cut 2

